

RoHS Compliance

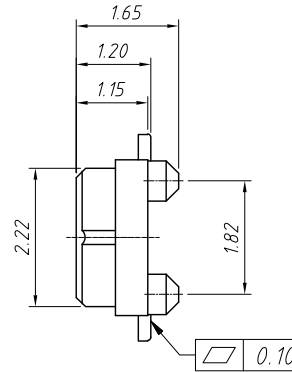
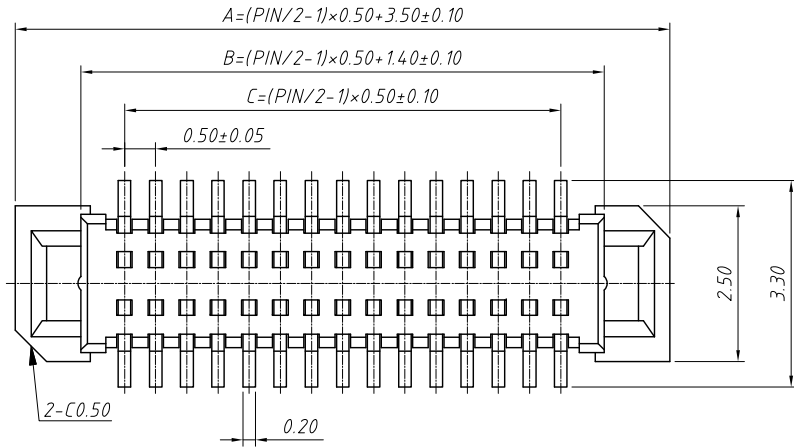

Material and Plated

- 1.Housing:High Temp Plastic,(LCP UL94V-0)
- 2.Contact: Phosphor Bronze
- 3.Plated:Gold Plated
- 4.Package:3000pcs/Reel

Specifications:

- 1.Current Rating:0.5A AC/DC
- 2.Voltage Rating:50V AC/DC
- 3.Contact Resistance:40mΩ max.
- 4.Insulation Resistance:100MΩ min.
- 5.Withstanding Voltage:500V AC for one minute
- 6.Operating Temperature Range:-25°C to +85°C
- 7.Storage Temperature Range:-10°C~+60°C

Mating Height Dimension

P/N Plug	P/N Socket	Matting Height
B0205-120M	B0205-126F	1.50
	B0205-176F	2.00

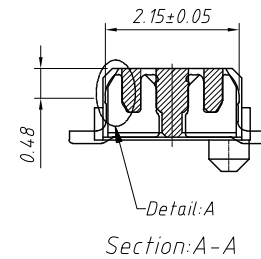
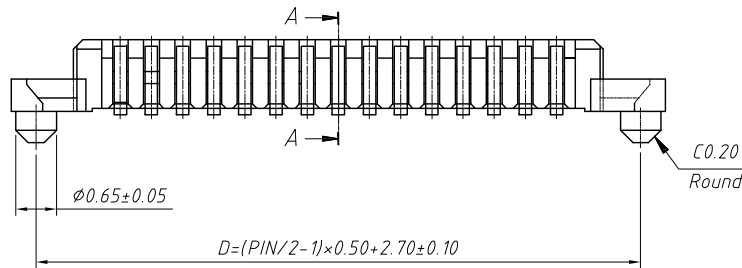

Order Information:

L-KLS1-B0205-120MXX-T3R

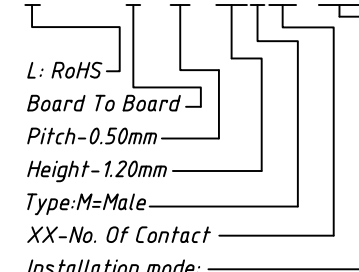

T=SMD Without Post, T3=SMD With Post
Packing:R=Reel T=Tube

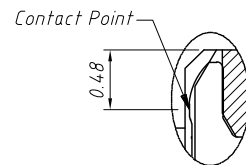
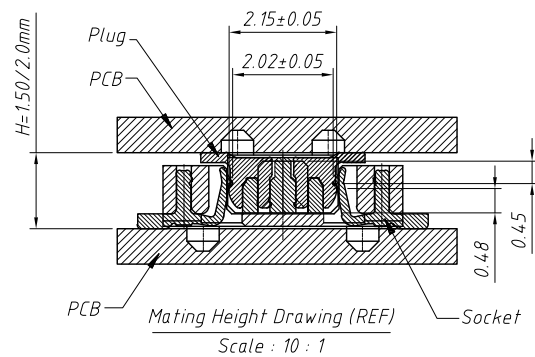

Scale:2:1
Detail:A

ANGLE TOLERANCE	PROJECTION	Description:	
$\pm 3^\circ$			0.5mm Board To Board Plug 1.2mm Height
GENERAL TOLERANCE	UNITS	mm	KLS P/N:
x.x ± 0.30	SHEET SIZE	A4	L-KLS1-B0205-120MXX-T3R
x.xx ± 0.20	Draw:	Daniel	2020-11-11
x.xxx ± 0.10	Check:	Daniel	2020-11-11



NingBo KLS ELECTRONIC CO.,L TD.

1
RoHS Compliance

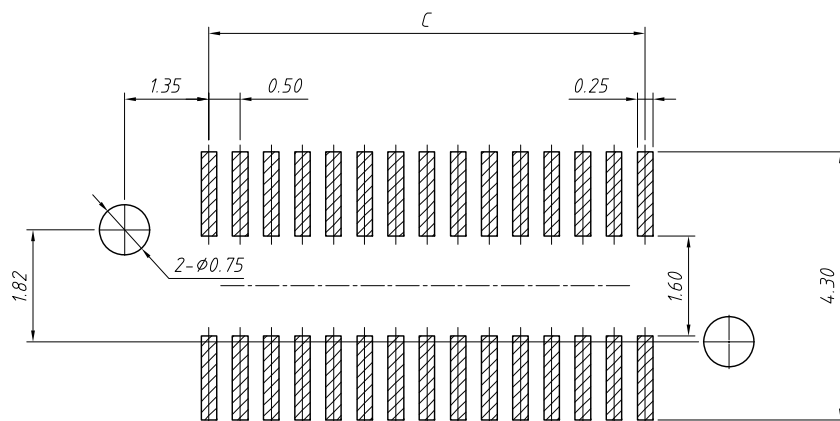
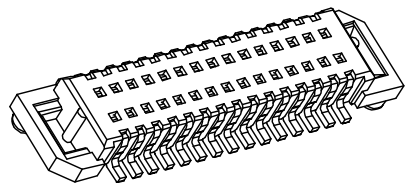

PCB LAYOUT

Circuit	A	B	C	D	Circuit	A	B	C	D
10	5.50	3.40	2.00	4.70	32	11.00	8.90	7.50	10.20
12	6.00	3.90	2.50	5.20	34	11.50	9.40	8.00	10.70
14	6.50	4.40	3.00	5.70	36	12.00	9.90	8.50	11.20
16	7.00	4.90	3.50	6.20	40	13.00	10.90	9.50	12.20
18	7.50	5.40	4.00	6.70	50	15.50	13.40	12.00	14.70
20	8.00	5.90	4.50	7.20	60	18.00	15.90	14.50	17.20
22	8.50	6.40	5.00	7.70	70	20.50	18.40	17.00	19.70
24	9.00	6.90	5.50	8.20	80	23.00	20.90	19.50	22.20
26	9.50	7.40	6.00	8.70	100	28.00	25.90	24.50	27.20
28	10.00	7.90	6.50	9.20	120	33.00	30.90	29.50	32.20
30	10.50	8.40	7.00	9.70					

Material and Plated
 1.Housing:High Temp Plastic,(LCP UL 94 V-0)
 2.Contact: Phosphor Bronze
 3.Plated:Gold Plated
 4.Package:3000pcs/Reel

Specifications:
 1.Current Rating:0.5A AC/DC
 2.Voltage Rating:50V AC/DC
 3.Contact Resistance:40mΩ. max.
 4.Insulation Resistance:100MΩ. min.
 5.Withstanding Voltage:500V AC for one minute
 6.Operating Temperature Range:-25°C to + 85°C
 7.Storage Temperature Range:-10°C ~ + 60°C

Order Information:
 L-KLS1-B0205-120MXX-T3R
 L: RoHS
 Board To Board
 Pitch-0.50mm
 Height-1.20mm
 Type:M=Male
 XX-No. Of Contact
 Installation mode:
 T=SMD Without Post, T3=SMD With Post
 Packing:R=Reel T=Tube

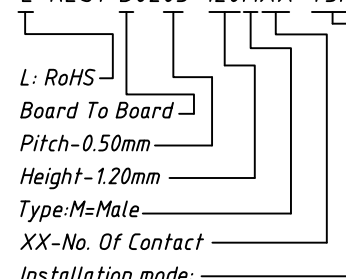

ANGLE TOLERANCE	PROJECTION	Description:	0.5mm Board To Board Plug 1.2mm Height
±3°			
GENERAL TOLERANCE	UNITS	mm	KLS P/N: L-KLS1-B0205-120MXX-T3R
x.x ±0.30	SHEET SIZE	A4	NingBo KLS ELECTRONIC CO.,L TD.
x.xx ±0.20	Draw:	Daniel 2020-11-11	
x.xxx ±0.10	Check:	Daniel 2020-11-11	

RoHS Compliance

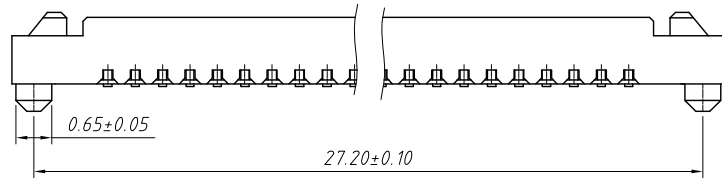
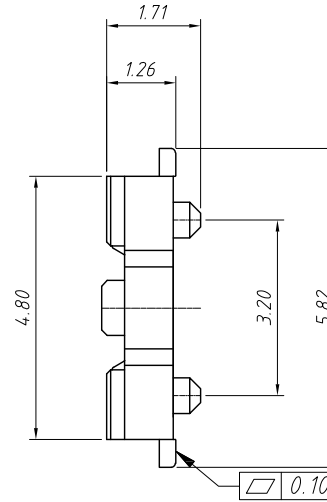
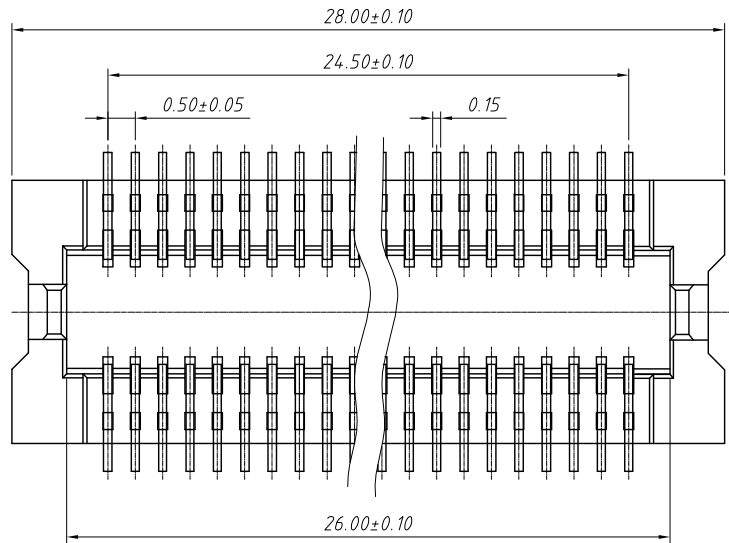

Mated Drawing (REF)
Scale : 5 : 1

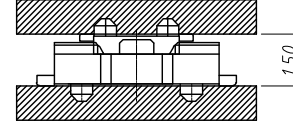

Material and Plated

- 1.Housing:High Temp Plastic,(LCP UL94V-0)
- 2.Contact: Phosphor Bronze
- 3.Plated:Gold Plated
- 4.Package:1800pcs/Reel

Specifications:

- 1.Current Rating:0.5A AC/DC
- 2.Voltage Rating:50V AC/DC
- 3.Contact Resistance:40mΩ. max.
- 4.Insulation Resistance:100MΩ. min.
- 5.Withstanding Voltage:500V AC for one minute
- 6.Operating Temperature Range:-25°C to + 85°C

Mating Height Dimension

P/N Plug	P/N Socket	Matting Height
B0205-120M	B0205-126F	1.50

Order Information:

L-KLS1-B0205-126FXX-T3R

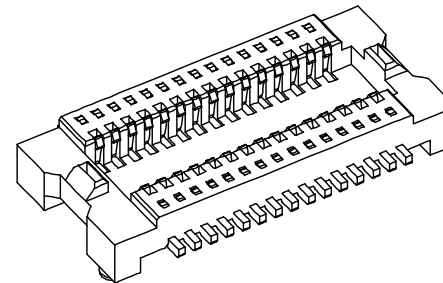
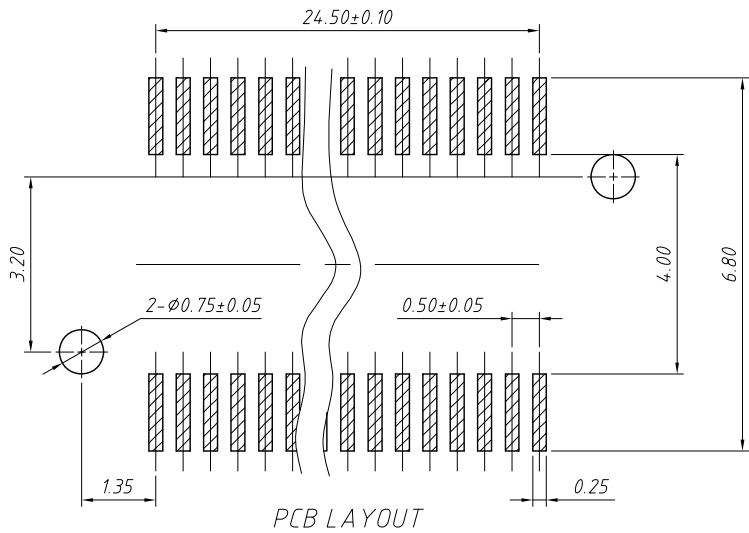
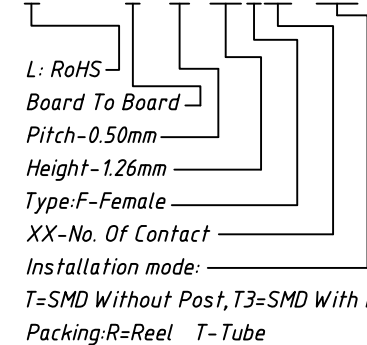

ANGLE TOLERANCE	PROJECTION	Description:	0.5mm Board To Board Socket 1.26mm Height
±3°			
GENERAL TOLERANCE	UNITS	mm	KLS P/N:
x.x ±0.30	SHEET SIZE	A4	L-KLS1-B0205-126FXX-T3R
x.xx ±0.20	Draw:	Daniel	2020-11-11
x.xxx ±0.10	Check:	Daniel	2020-11-11



NingBo KLS ELECTRONIC CO.,L TD.

1 RoHS Compliance

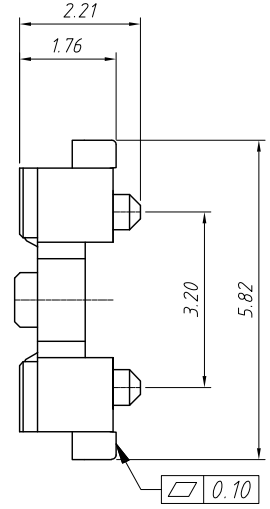
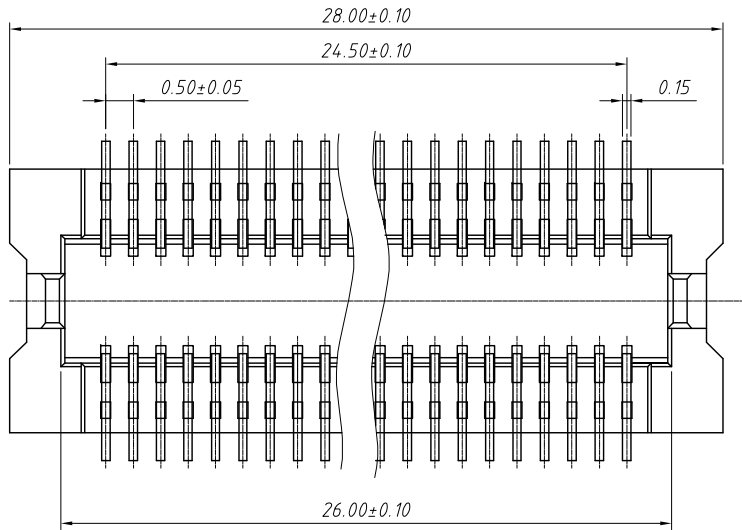

Material and Plated
 1.Housing:High Temp Plastic,(LCP UL94V-0)
 2.Contact: Phosphor Bronze
 3.Plated:Gold Plated
 4.Package:1800pcs/Reel

Specifications:
 1.Current Rating:0.5A AC/DC
 2.Voltage Rating:50V AC/DC
 3.Contact Resistance:40mΩ. max.
 4.Insulation Resistance:100MΩ. min.
 5.Withstanding Voltage:500V AC for one minute
 6.Operating Temperature Range:-25°C to + 85°C
 7.Storage Temperature Range:-10°C to + 60°

Mating Height Dimension

P/N Plug	P/N Socket	Matting Height
B0205-120M	B0205-176F	2.00

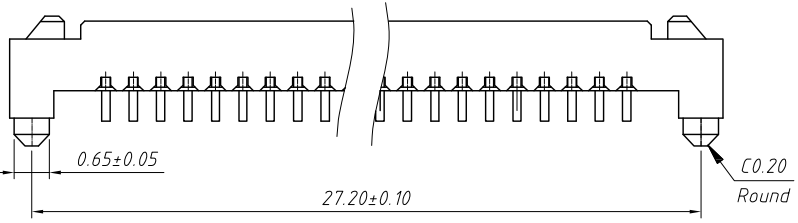

Order Information:

L-KLS1-B0205-176FXX-T3R

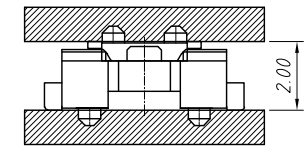
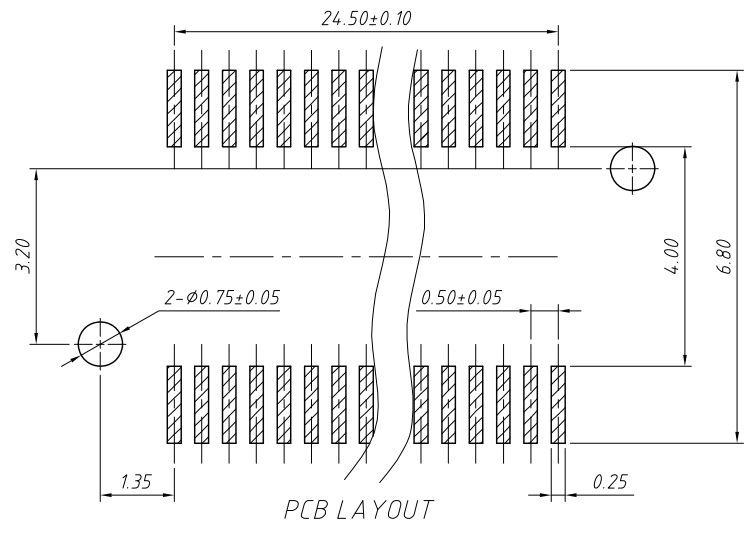
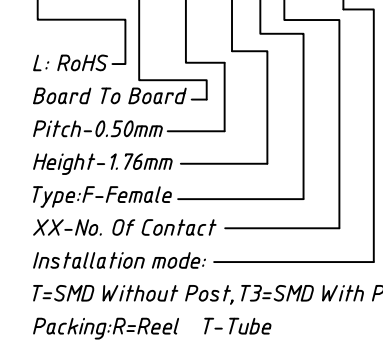

Mated Drawing (REF)
Scale : 5 : 1

ANGLE TOLERANCE	PROJECTION	Description:	0.5mm Board To Board Socket 1.76mm Height
±3°			
GENERAL TOLERANCE	UNITS	mm	KLS P/N:
x.x ±0.30	SHEET SIZE	A4	L-KLS1-B0205-176FXX-T3R
x.xx ±0.20	Draw:	Daniel	2020-11-11
x.xxx ±0.10	Check:	Daniel	2020-11-11

